

Data sheet

Stainless steel ball valve, Eco-Line light, G 1-1/2", 0 to 63bar

Item number:

VS4500-6/4



Example illustration

Item description

Materials:

Housing: 1.4408, ball: 1.4408, seal: PTFE (15% GF), handle: 1.4301

Temperature range:

-20°C to +200°C

Operating range:

Water, steam, oil, compressed air, fuels, solvents, aggressive media

Optional:

Certificate 3.1

Properties

Version	Standard
G	G 1-1/2"
DN [mm]	38
L [mm]	98,5
PN [bar]	0 to 63
H [mm]	94
R [mm]	165

Further information:

Weight	1,5 kg / pcs
GTIN	4050571406691
Customs duty number	84818081
RoHS compliant	Yes

Drawing:

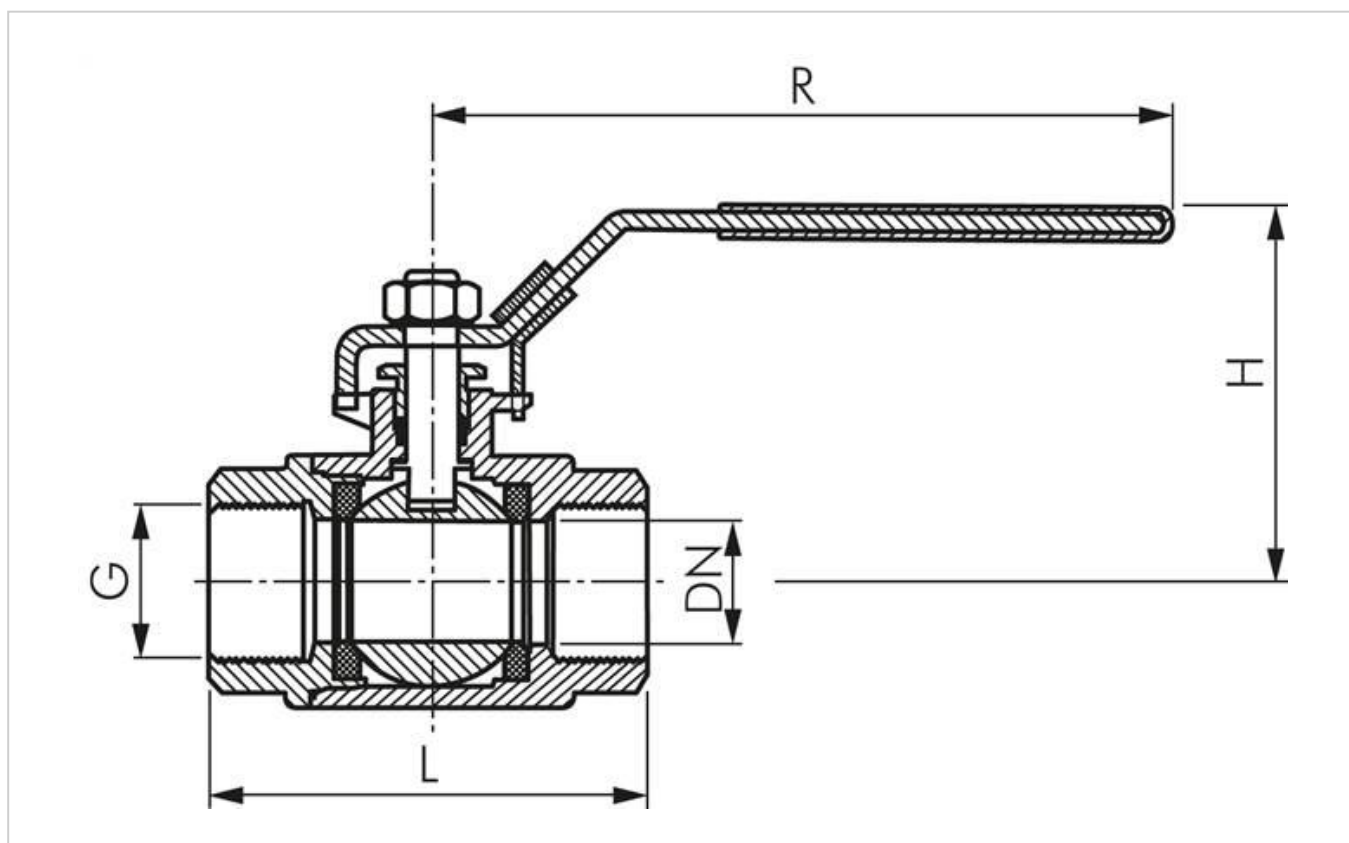

Drawing

Diagramm 3 - PN 63

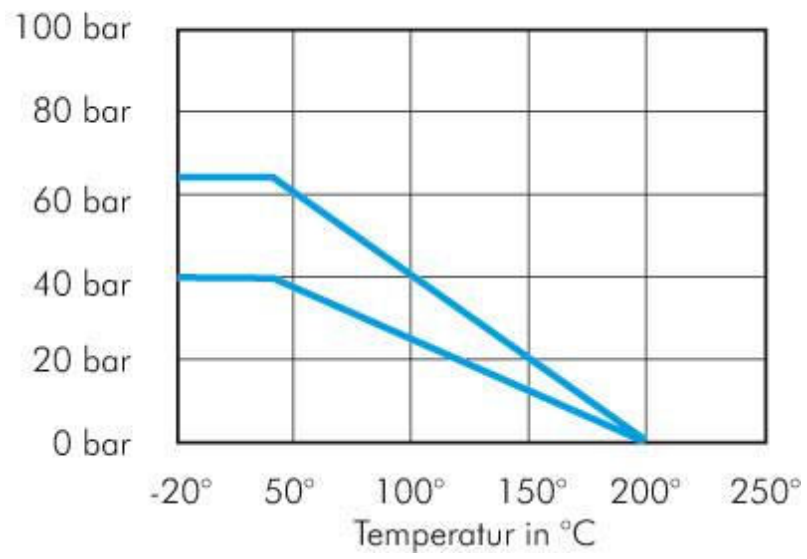

Drawing: Pressure-temperature diagram