

Data sheet

stainless steel mini ball valve, G 1/8" Female thread /male thread, PN 63

Item number:

VS405-1/8 ES



Example illustration

Item description

Materials:

Housing: 1.4408, ball: 1.4408, handle screw: 1.4301, seal: PTFE / FKM, handle: zinc diecasting

Temperature range:

-20°C to +200°C

Operating range:

Water, oil, compressed air, fuels, solvents, aggressive media

Optional:

Certificate 3.1

Properties

Version	Female thread /male thread
Thread G	G 1/8"
Thread G	G 1/8" (male thread)
DN [mm]	5
L [mm]	39
PN [bar]	0 to 63
H [mm]	27
R [mm]	22

Further information:

Weight	90 g / pcs
GTIN	4050571410896
Customs duty number	84818081
RoHS compliant	Yes

Drawing:

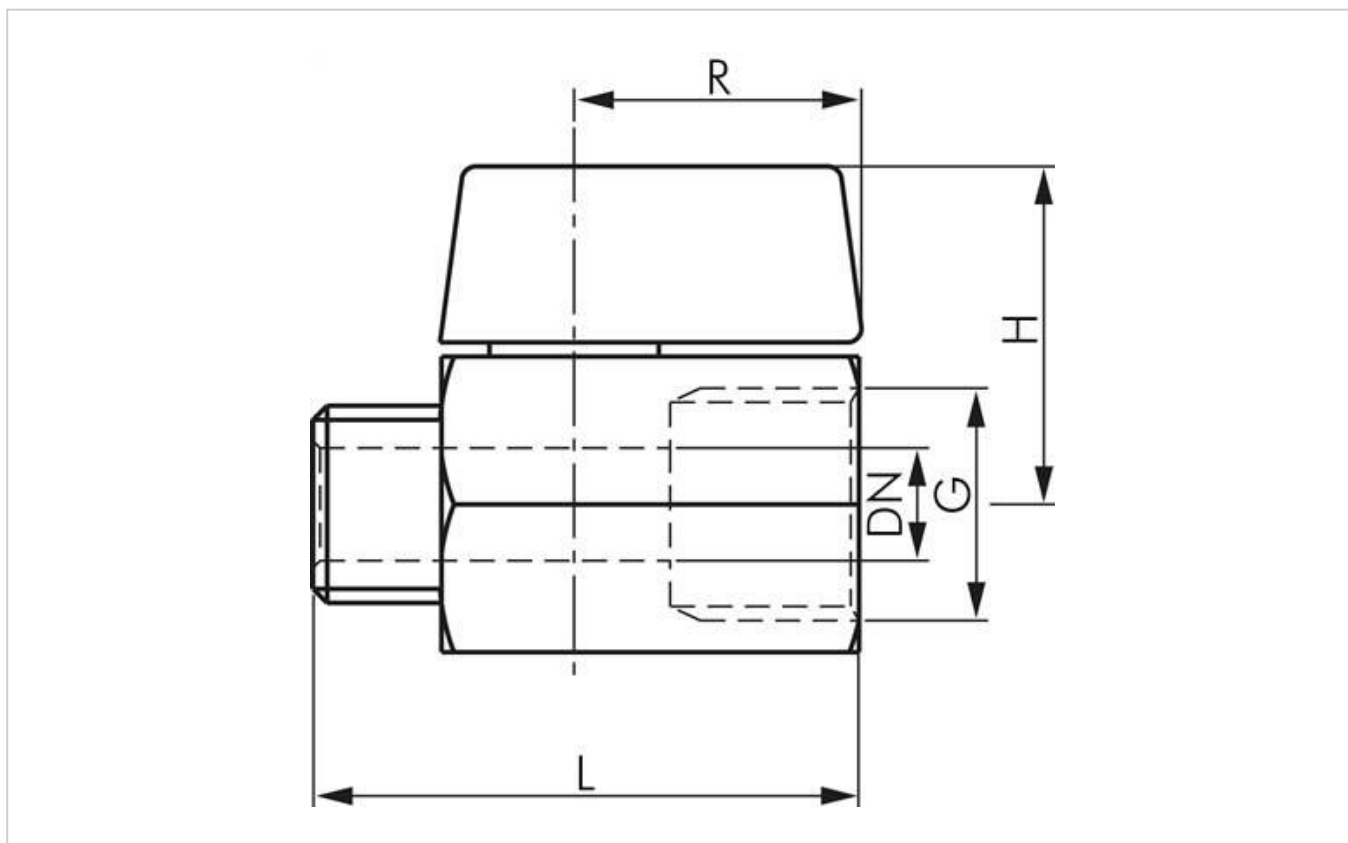

Drawing: Female / male thread