

Mini-Kugelhahn

Mini-Kugelhahn

Mini ball valve

Valvola a sfera mini M/F

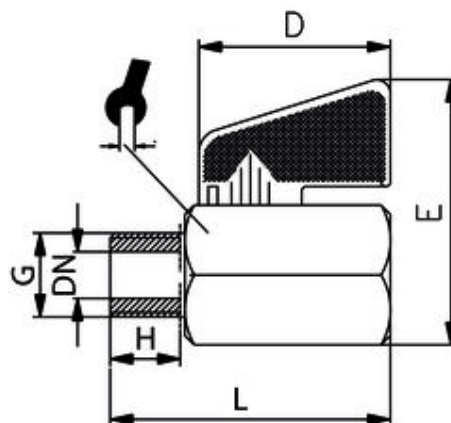

Code	G	H	L	D	E	DN	sw
VS405-1/4	G1/4	9	39	30	37	8	20

Betriebstemperatur:	0 °C bis +90 °C
Operating temperature:	0 °C to +90 °C
Temperatura di esercizio:	da 0 °C a +90 °C
Betriebsdruck:	15 bar
Inlet pressure:	15 bar
Pressione di esercizio:	15 bar
Körper/Kugel:	Messing verchromt
Body/ball:	brass chrome-plated
Corpo/sfera:	ottone cromato
Griff:	PA66
Handle:	PA66
Leva:	PA66
O-Ring:	PTFE
O-ring:	PTFE
O-ring:	PTFE
Gewinde:	DIN EN ISO 228
Thread:	DIN EN ISO 228
Filettatura:	DIN EN ISO 228
Einsatzgebiete:	Luft-, Wasser-, Ölkreisläufe, Einsatz auch im mittleren bis niedrigen Vakuum möglich.
Applications:	Air, Water and Oil dynamics circuits, use also in medium to low vacuum.
Campo di applicazione:	Aria, acqua e circuiti oleodinamici; e' possibile l'utilizzo per medio/ basso vuoto pneumatico.