

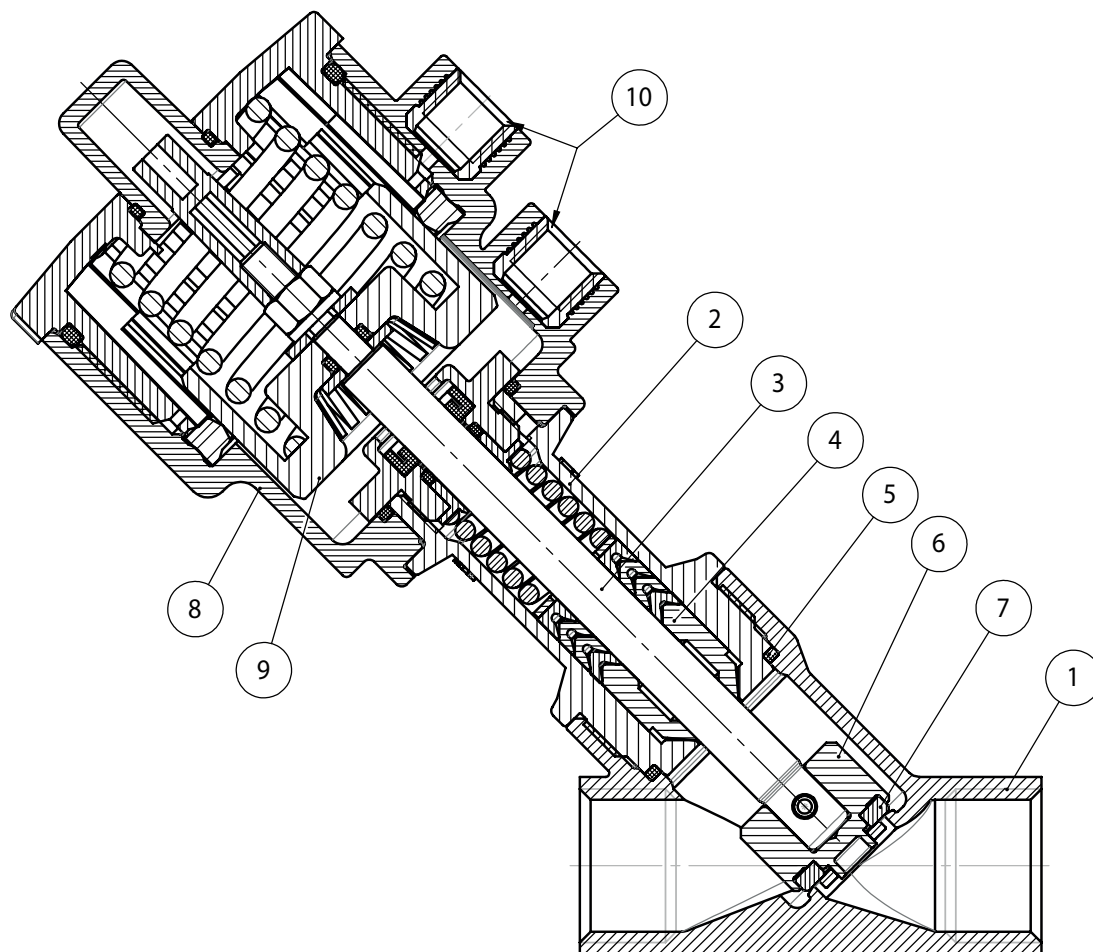

ZEUS TESTA Ø40 HEAD Ø40



N°	MATERIALI	MATERIALS
1	Corpo valvola <i>Valve body</i>	Bronzo <i>Bronze</i> CuSn5Zn5Pb5-B
2	Cannotto premistoppa <i>Sleeve</i>	Ottone EN 12165 CW617N <i>Brass EN 12165 CW617N</i>
3	Stelo <i>Stem</i>	AISI 316L
4*	Guarnizioni stelo <i>Stem seals</i>	R-PTFE
5*	Guarnizione corpo <i>Body seal</i>	GRAPHITE
6	Otturatore <i>Plug</i>	AISI 316L
7	Guarnizione otturatore <i>Plug seal</i>	PTFE
8	Testa di comando <i>Actuator cylinder</i>	Poliammide PA 66 + GF 30%
9	Pistone <i>Piston</i>	PBT + GF 20%
10	Inserti di pilotaggio <i>Threading inserts</i>	AISI 303

* Per applicazioni alta purezza sono disponibili guarnizioni stelo in PTFE vergine e guarnizione corpo in Peek
 For high purity application are allowable stem seals in virgin PTFE and body seals in Peek

Diagramma pressione/temperatura
Temperature/pressure diagram



Diagramma T ambiente/T fluido intercettabile
Ambient temperature/Media temperature diagram



ZEUS

**ZEUS****N.C. Normalmente Chiusa bidirezionale** (Con ingresso sotto l'otturatore si evita il colpo d'ariete).**N.C. Normally Closed bidirectional** (With the flow coming from below the plug you avoid water hammering).**CON INGRESSO DEL FLUIDO SOTTO L'OTTURATORE WITH THE FLOW FROM BELOW THE PLUG**

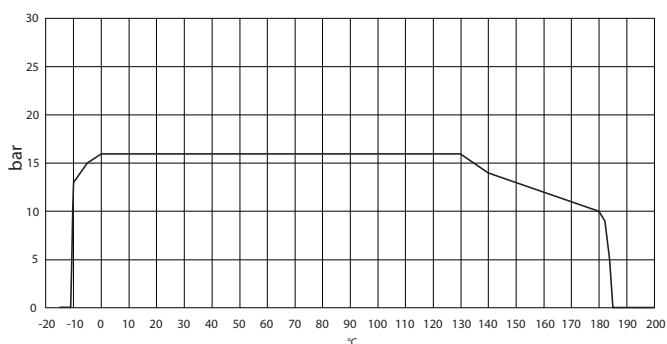
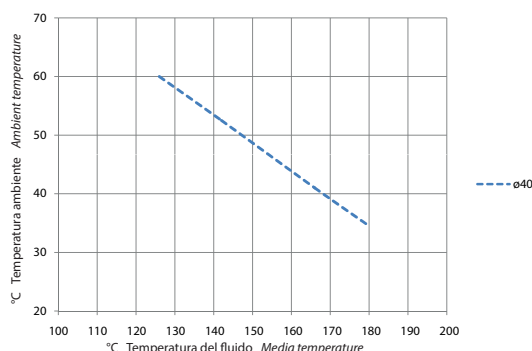
DN [mm]	Filettatura Threading	CODICE BRONZO CODE BRONZE	Kv m ³ /h	Ø Testa comando Ø Control head	P comando bar P control bar		P intercettata P operating ΔP max. bar	Peso Weight Kg. BRONZO	KIT OTTURATORE DI RICAMBIO PLUG SPARE KIT	KIT TESTA DI RICAMBIO HEAD SPARE KIT
					Min	Max				
15	3/8"	J9SPG1403	4,5	40	4,2	10	16	1,1	KGJP2303	J9SPG14R3
15	3/8"	J9SPG1603	4,9	50	4	10	16	1,1	KGJP2003	J9SPG16R3
15	1/2"	J9SPG1404	5,3	40	4,2	10	16	1	KGJP2303	J9SPG14R4
15	1/2"	J9SPG1604	5,7	50	4	10	16	1	KGJP2003	J9SPG16R4
20	3/4"	J9SPG1405	9,2	40	4,2	10	8	1,2	KGJP2305	J9SPG14R5
20	3/4"	J9SPG1605	10,5	50	4	10	10	1,2	KGJP2005	J9SPG16R5
20	3/4"	J9SPG1805	10,8	63	4	10	16	1,2	KGJP2005	J9SPG18R5
25	1"	J9SPG1806	20	63	4	10	11	1,6	KGJP2005	J9SPG18R6
25	1"	J9SPG2106	20	90	4	8	16	1,7	KGJP2106	J9SPG21R6
32	1 1/4"	J9SPG2107	29	90	4	8	14	3	KGJP2107	J9SPG21R7
40	1 1/2"	J9SPG2108	46	90	4	8	11	3,4	KGJP2108	J9SPG21R8
40	1 1/2"	J9SPG2308	46,5	110	4	8	16	4	KGJP2108	J9SPG23R8
50	2"	J9SPG2309	67	110	4	8	10	5,8	KGJP2109	J9SPG23R9

Il kit testa di ricambio comprende tutto l'articolo meno il corpo valvola.

The "piloting head replacement Kit" includes the complete item without the valve body only.

Il kit otturatore di ricambio comprende l'otturatore e le guarnizioni necessarie.

The shutter "replacement Kit" includes the shutter and the necessary seals.

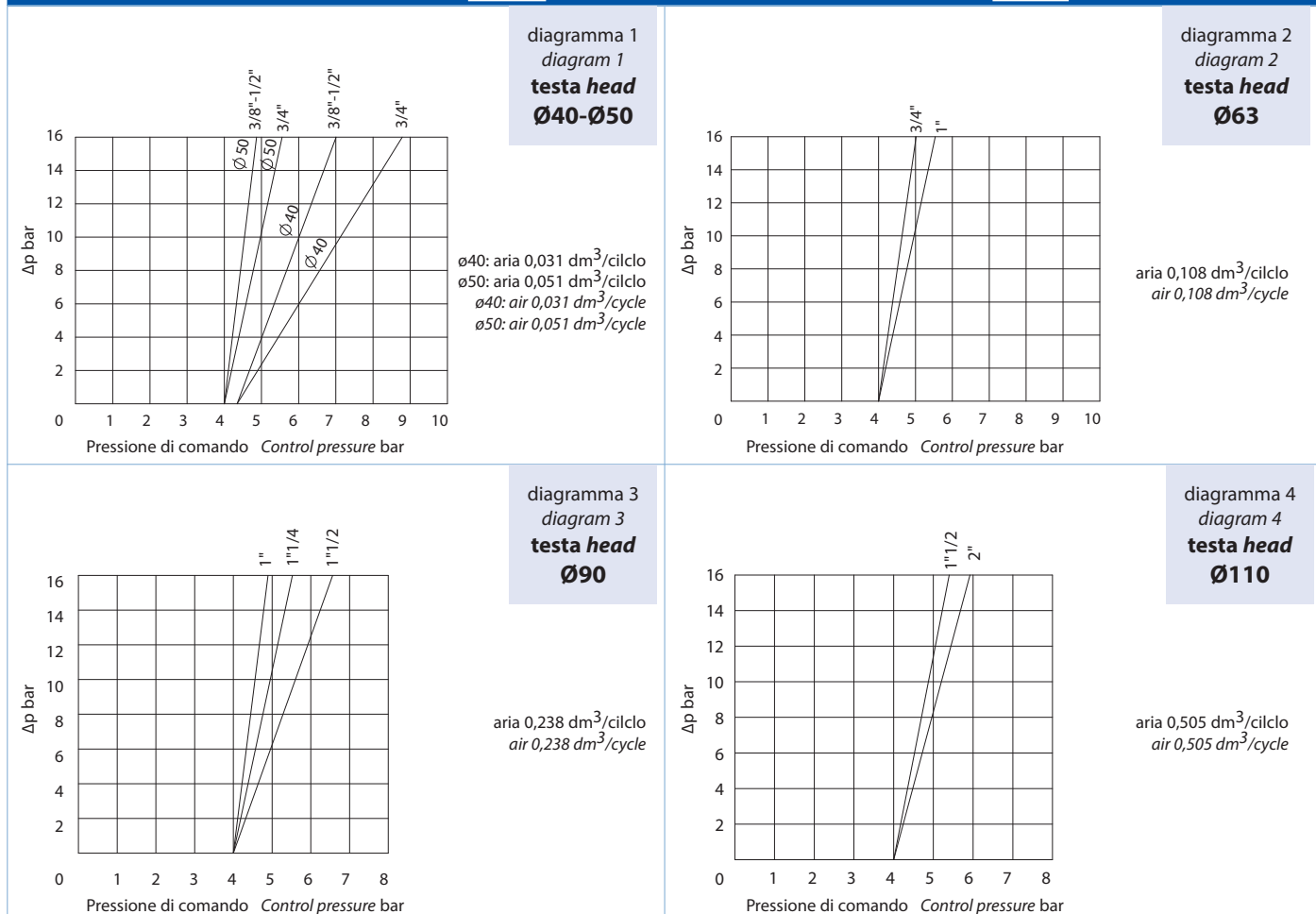
CON INGRESSO DEL FLUIDO SOPRA L'OTTURATORE WITH THE FLOW FROM ABOVE THE PLUG

Nei diagrammi le linee tratteggiate indicano le versioni disponibili a richiesta.

In the diagrams, the dash lines indicate versions available on request.



ZEUS

N.C. Normalmente Chiusa con ingresso sopra l'otturatore.

N.C. Normally Closed with the flow from above the plug.

DN [mm]	Filettatura Threading	CODICE BRONZO CODE BRONZE	Kv m ³ /h	Ø Testa comando Ø Control head	P comando bar P control bar Min Max	P intercettata P operating ΔP max. bar	Peso Weight Kg. BRONZO	KIT OTTURATORE DI RICAMBIO PLUG SPARE KIT	KIT TESTA DI RICAMBIO HEAD SPARE KIT
15	3/8"	J9CPG1403	4,5	40	2,5 10	diagram n° 5	1	KGJP2303	J9CPG14R3
15	3/8"	J9CPG1603	4,9	50	1,8 10	diagram n° 5	1	KGJP2003	J9CPG16R3
15	1/2"	J9CPG1404	5,3	40	2,5 10	diagram n° 5	1	KGJP2303	J9CPG14R4
15	1/2"	J9CPG1604	5,7	50	1,8 10	diagram n° 5	1	KGJP2003	J9CPG16R4
20	3/4"	J9CPG1405	9,2	40	2,5 10	diagram n° 5	1,2	KGJP2305	J9CPG14R5
20	3/4"	J9CPG1605	10,5	50	1,8 10	diagram n° 5	1,2	KGJP2005	J9CPG16R5
25	1"	J9CPG1806	20	63	1,8 10	diagram n° 6	1,6	KGJP2006	J9CPG18R6
32	1 1/4"	J9CPG2107	29	90	1,8 8	diagram n° 7	3	KGJP2107	J9CPG21R7
40	1 1/2"	J9CPG2108	46	90	1,8 8	diagram n° 7	3,7	KGJP2108	J9CPG21R8
40	1 1/2"	J9CPG2308	46,5	110	1,8 8	diagram n° 8	4,6	KGJP2108	J9CPG23R8
50	2"	J9CPG2109	59	90	1,8 8	diagram n° 7	4,4	KGJP2109	J9CPG21R9
50	2"	J9CPG2309	67	110	1,8 8	diagram n° 8	5,6	KGJP2109	J9CPG23R9

Il kit testa di ricambio comprende tutto l'articolo meno il corpo valvola.

The "piloting head replacement Kit" includes the complete item without the valve body only.

Il kit otturatore di ricambio comprende l'otturatore e le guarnizioni necessarie.

The shutter "replacement Kit" includes the shutter and the necessary seals.

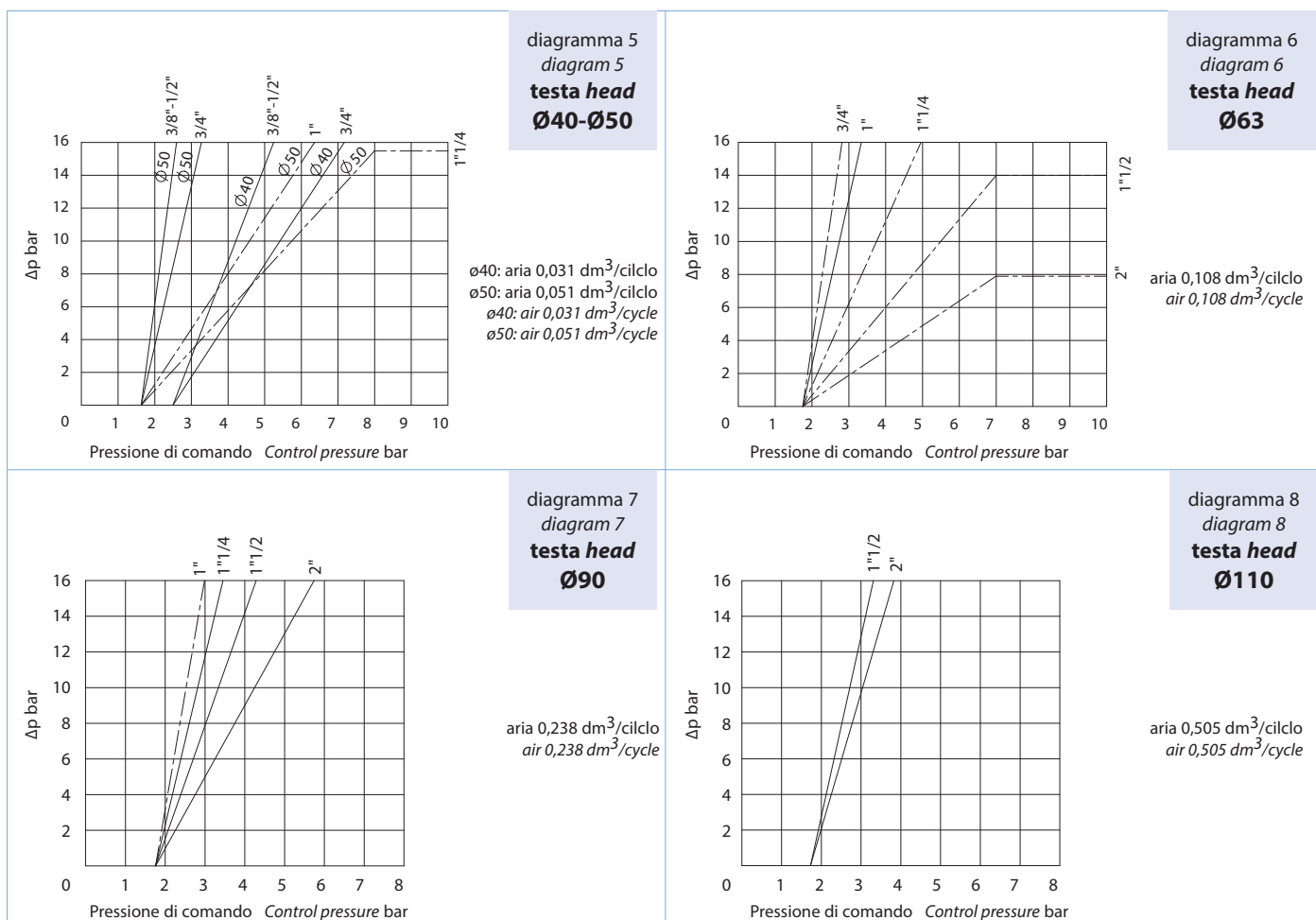

Nei diagrammi le linee tratteggiate indicano le versioni disponibili a richiesta.

In the diagrams, the dash lines indicate versions available on request.



ZEUS

N.A. Normalmente Aperta con ingresso sotto l'otturatore

N.O. Normally Open with flow from below the plug

DN [mm]	Filettatura Threading	CODICE BRONZO CODE BRONZE	Kv m ³ /h	Ø Testa comando Ø Control head	P comando bar P control bar		P intercettata P operating ΔP max. bar	Peso Weight Kg. BRONZO	KIT OTTURATORE DI RICAMBIO PLUG SPARE KIT	KIT TESTA DI RICAMBIO HEAD SPARE KIT
					Min	Max				
15	3/8"	J9APG1603	4,9	50	2,8	10	diagram n° 9	1	KGJP2003	J9APG16R3
15	1/2"	J9APG1604	5,7	50	2,8	10	diagram n° 9	1	KGJP2003	J9APG16R4
20	3/4"	J9APG1605	10,5	50	2,8	10	diagram n° 9	1,2	KGJP2005	J9APG16R5
25	1"	J9APG1806	20	63	3,2	10	diagram n° 10	1,6	KGJP2006	J9APG18R6
32	1 1/4"	J9APG1807	28,5	63	3,2	10	diagram n° 10	2	KGJP2007	J9APG18R7
40	1 1/2"	J9APG2108	46	90	2	8	diagram n° 11	3,7	KGJP2108	J9APG21R8
50	2"	J9APG2309	67	110	2,2	8	diagram n° 12	5,6	KGJP2109	J9APG23R9

Il kit testa di ricambio comprende tutto l'articolo meno il corpo valvola.
The "piloting head replacement Kit" includes the complete item without the valve body only.

Il kit otturatore di ricambio comprende l'otturatore e le guarnizioni necessarie.
The shutter "replacement Kit" includes the shutter and the necessary seals.

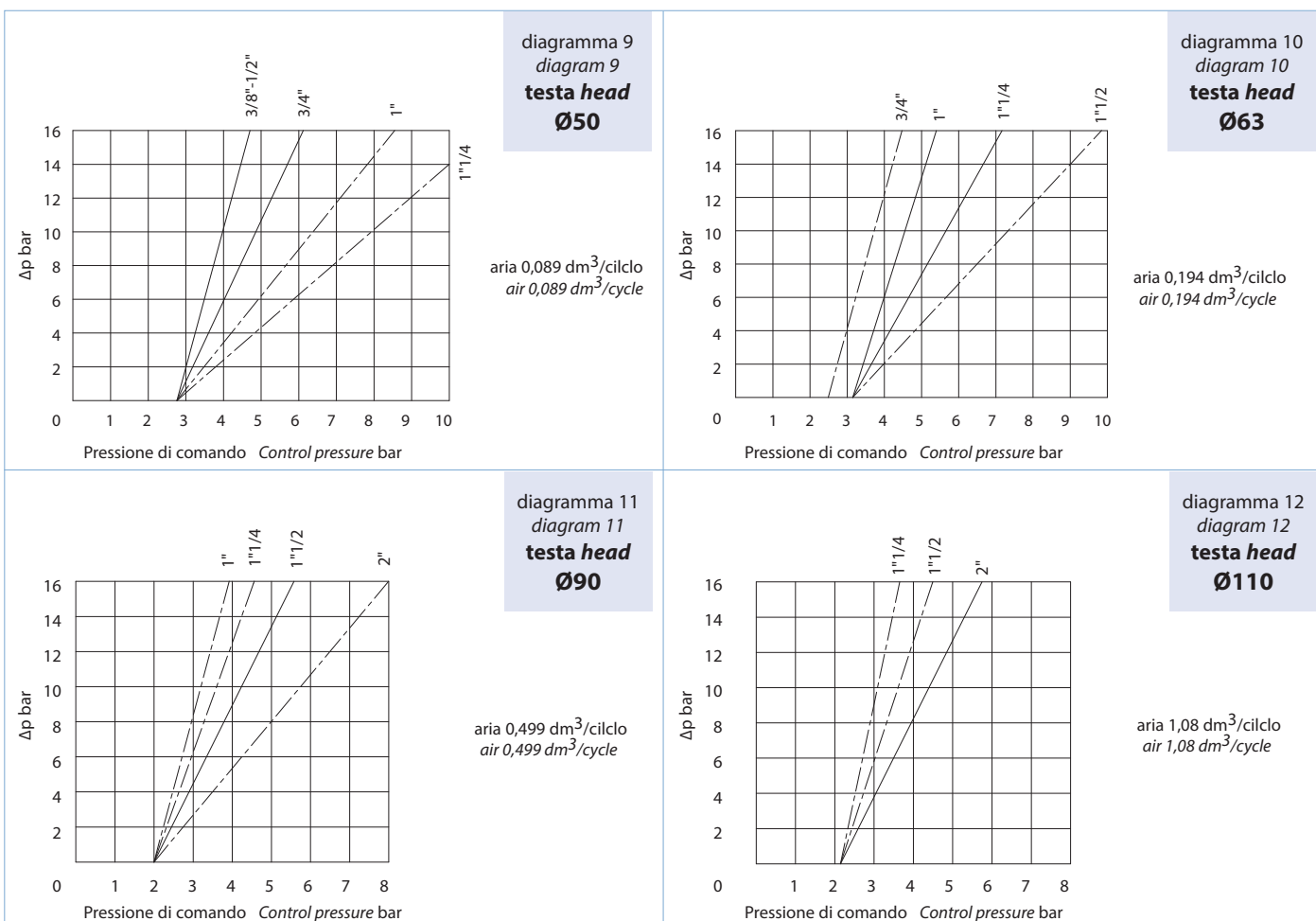

Nei diagrammi le linee tratteggiate indicano le versioni disponibili a richiesta. In the diagrams, the dash lines indicate versions available on request.



ZEUS

Doppio effetto bidirezionale

Double acting bidirectional

DN [mm]	Filettatura Threading	CODICE BRONZO CODE BRONZE	Kv m ³ /h	Ø Testa comando Ø Control head	P comando bar P control bar Min Max	P intercettata P operating ΔP max. bar	Peso Weight Kg. BRONZO	KIT OTTURATORE DI RICAMBIO PLUG SPARE KIT	KIT TESTA DI RICAMBIO HEAD SPARE KIT
15	3/8"	J9DPG1603	4,9	50	0,8 8	diagram n° 13	1	KGJP2003	J9DPG16R3
15	1/2"	J9DPG1604	5,7	50	0,8 8	diagram n° 13	1	KGJP2003	J9DPG16R4
20	3/4"	J9DPG1605	10,5	50	0,8 8	diagram n° 13	1,2	KGJP2005	J9DPG16R5
25	1"	J9DPG1806	20	63	0,8 8	diagram n° 14	1,6	KGJP2006	J9DPG18R6
32	1 1/4"	J9DPG1807	28,5	63	0,8 8	diagram n° 14	1,9	KGJP2007	J9DPG18R7
40	1 1/2"	J9DPG1808	35	63	0,8 8	diagram n° 14	2,3	KGJP2008	J9DPG18R8
40	1 1/2"	J9DPG2108	46	90	0,8 8	diagram n° 15	3,6	KGJP2108	J9DPG21R8
50	2"	J9DPG2109	59	90	0,8 8	diagram n° 15	4,3	KGJP2009	J9DPG21R9

Il kit testa di ricambio comprende tutto l'articolo meno il corpo valvola.

The "piloting head replacement Kit" includes the complete item without the valve body only.

Il kit otturatore di ricambio comprende l'otturatore e le guarnizioni necessarie.

The shutter "replacement Kit" includes the shutter and the necessary seals.

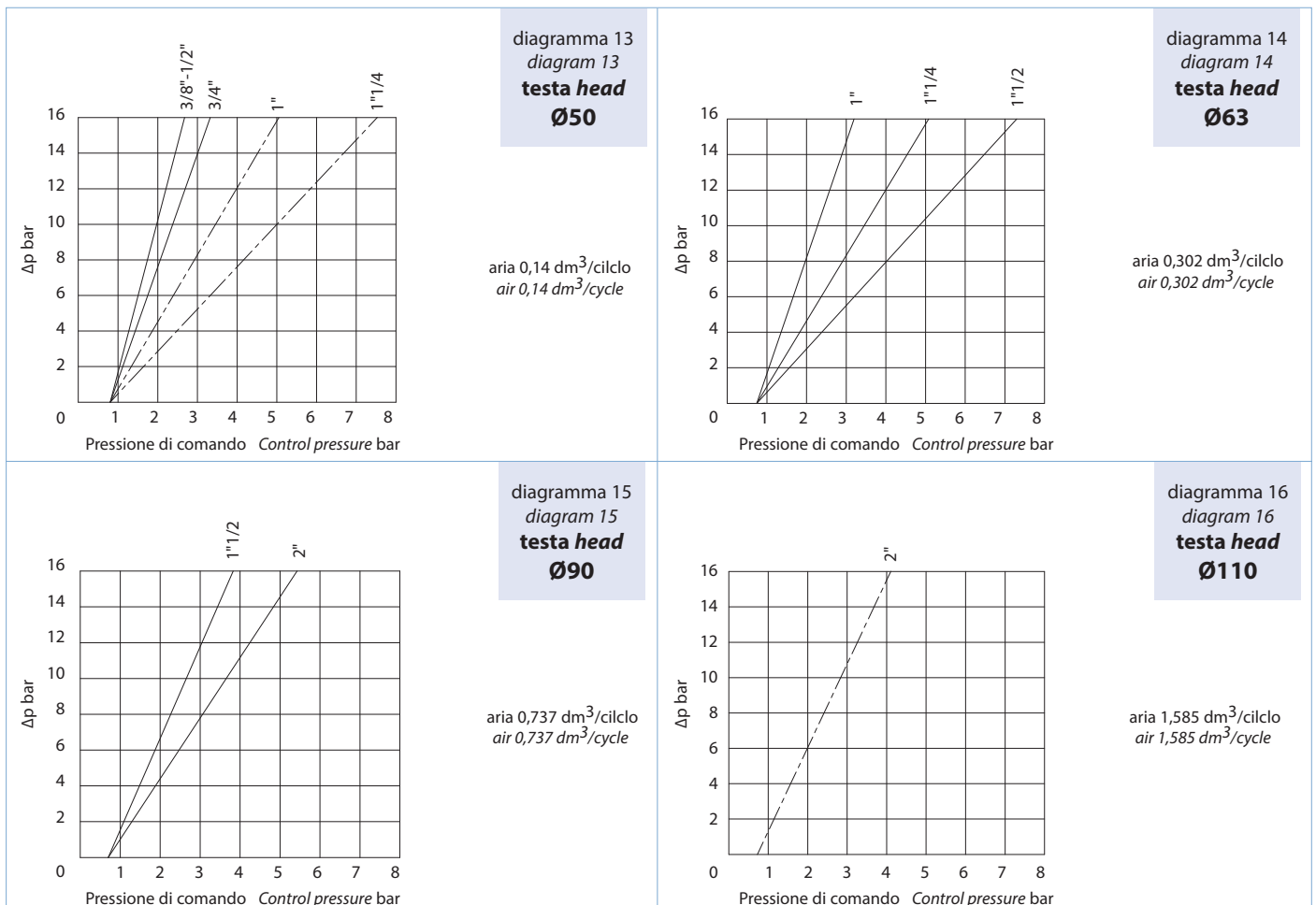

Nei diagrammi le linee tratteggiate indicano le versioni disponibili a richiesta.

In the diagrams, the dash lines indicate versions available on request.