

Data sheet

pressure booster (4 : 1) to 60 l/min with 5 l container

Item number:

DUE 60 B5



Example illustration

Item description

Completely plumbed with compressed air reservoir and pressure gauge

Application:

The pressure booster increases the input pressure to the value set on the control valve. The outlet pressure can measure max. four or. 2two times the input pressure, but can never exceed the max. outlet pressure. Should an individual consumer (clamping cylinder etc.) be operated with a pressure higher than the standard network pressure, the pressure booster can accordingly increase the supply pressure for this single consumer. An installed pressure regulator maintains a constant working pressure (with less pulsation).

Advantages:

High energy saving and no electrical energy necessary directly on consumer. For a further consumer, it is not necessary to pretension the entire compressed air network to a higher level.

Media:

Filtered, unoiled compressed air

Installation position:

horizontal

Temperature range:

+5°C to +50°C

Properties

Gear ration max.	4 : 1
Outlet pressure [bar]	2 - 20
Flow capacity* [l/min]	60
Container contents [LTR]	5
Compressed air connection	2 x quick coupling socket NW 7.2

Further information:

Weight	10 kg / Pcs
GTIN	4050571276911
Customs duty number	84148028

Drawing:

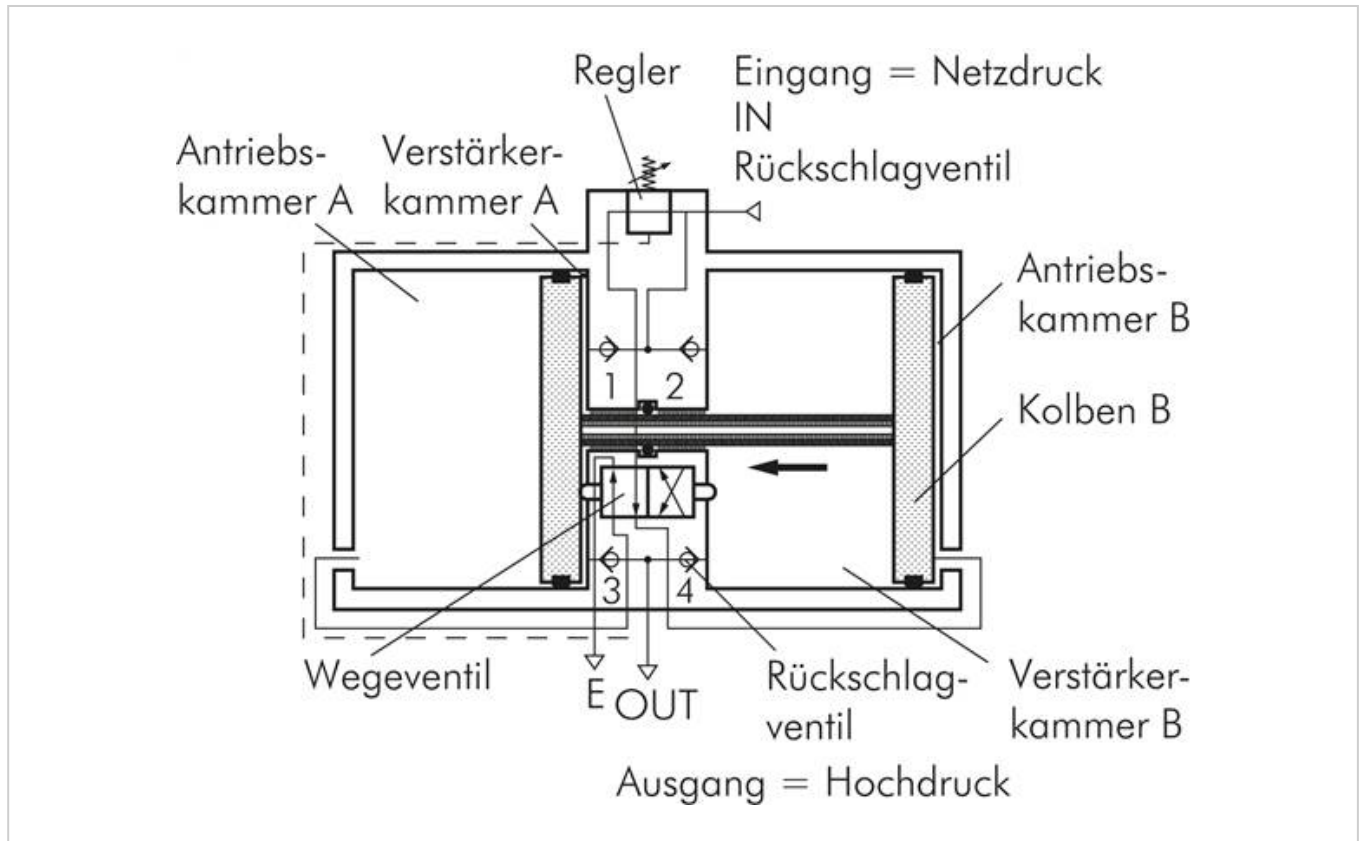

Drawing: Pressure booster