

avviatore progressivo G1/4"-G3/8"-G1/2"

G1/4"-G3/8"-G1/2" slow-start valve



Modalità di funzionamento

La valvola fornisce a un circuito pneumatico aria a pressione progressivamente crescente fino a raggiungere la metà della pressione di rete nel tempo impostato con la vite di regolazione integrata. Durante questa fase non devono essere attivi gli elementi del circuito che consumano aria. Raggiunta la soglia di commutazione, l'avviatore progressivo passa automaticamente a fornire la pressione di rete.

L'avviatore progressivo impedisce eventuali movimenti improvvisi dei dispositivi pneumatici montati nel circuito, che si potrebbero avere se venisse fornita immediatamente la pressione di rete.

Valve operation

The valve applies to a pneumatic circuit a progressively increasing pressure over a period of time set by the integrated screw. During this phase no air consumption is allowed in the circuit. After having reached the half of the system pressure, the slow-start valve begins to automatically feed the circuit with the system pressure.

The slow-start valve prevents from unexpected motions of the pneumatic devices in the circuit, which could happen by applying directly the system pressure.

CODICE DI ORDINAZIONE ORDER CODE		AVP 2K-00 16.311.0	AVP 3K-00 16.351.0	AVP 4K-00 16.331.0
Attacchi Ports		G1/4"	G3/8"	G1/2"
Temperatura di esercizio Temperature range		0 ... +50°C	0 ... +50°C	0 ... +50°C
Peso Weight		0.24 kg	0.24 kg	0.53 kg
Pressione di esercizio Working pressure range	P_{min} P_{max}	2.5 bar; 0.25 MPa 16 bar; 1.6 MPa	2.5 bar; 0.25 MPa 16 bar; 1.6 MPa	2.5 bar; 0.25 MPa 16 bar; 1.6 MPa
Portata massima Maximum flow rate	$p = 6.3 \text{ bar}; \Delta p = 1 \text{ bar}$ Q_{max}	1900 NI/min	1900 NI/min	400 NI/min

G1/4"-G3/8"

Rapporto tempo/pressione
Time/pressure ratio

G1/2"

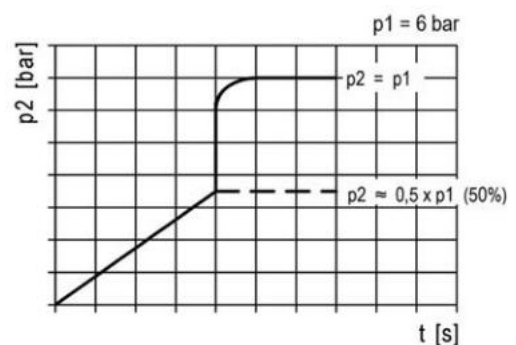
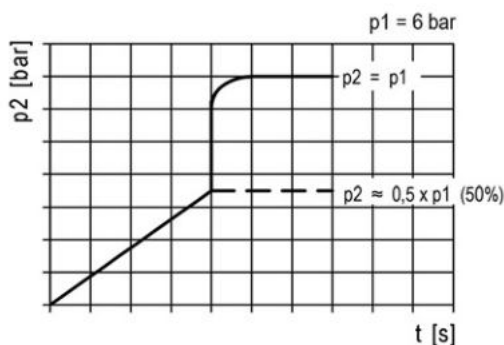

G1/4"-G3/8"

Portata in scarico
Exhaust flow rate

G1/2"

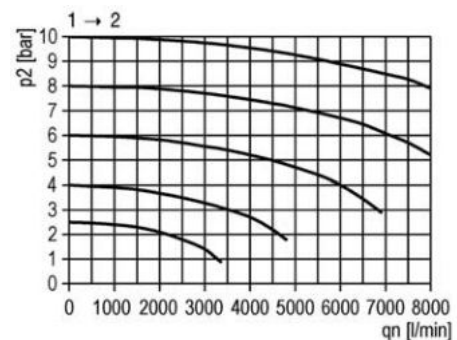
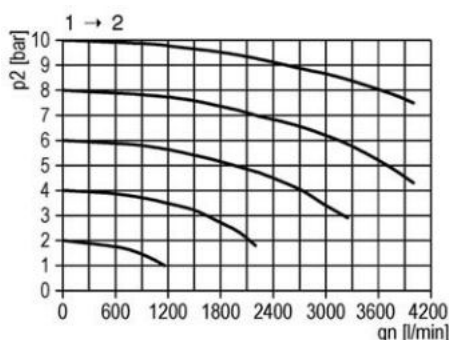

avviatore progressivo G1/4"-G3/8"-G1/2"

G1/4"-G3/8"-G1/2" slow-start valve



AVP 2K-00

AVP 3K-00

A richiesta disponibile con filetti NPT
On request available with NPT threads

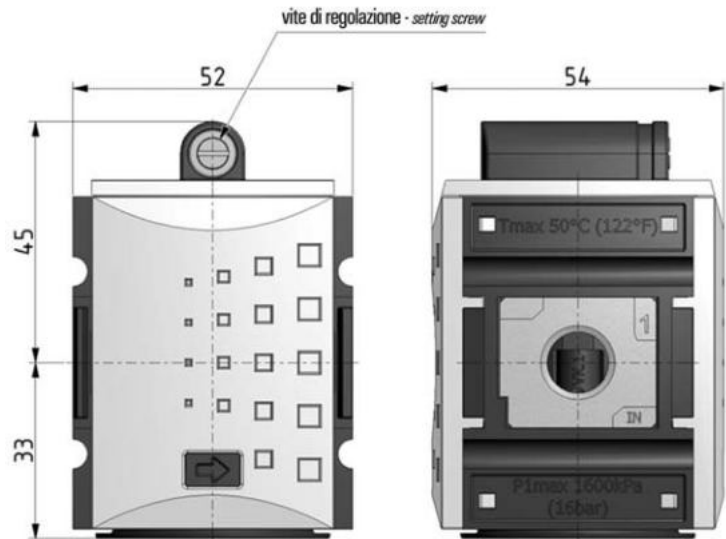
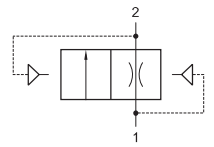

AVP 4K-00

A richiesta disponibile con filetti NPT
On request available with NPT threads

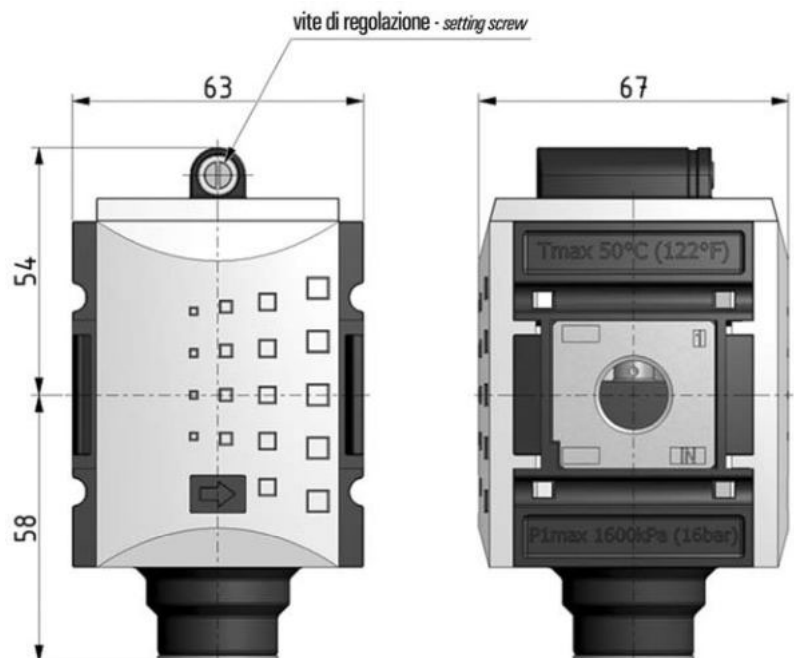

Materiali

Corpo: tecnopolimero

Guarnizioni: NBR

Parti interne: ottone e INOX

Materials

Body: technopolymer

Seals: NBR

Internal parts: brass and stainless steel

La staffa di fissaggio deve essere acquistata separatamente.

Mounting bracket is bought separately.