

valvole ad azionamento manuale

manually actuated valves

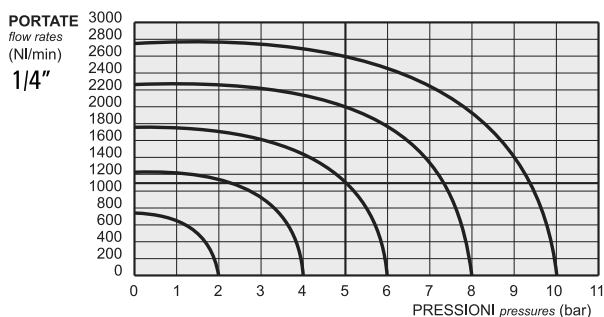

- Valvole a spola 3/2-5/2-5/3 con attacchi filettati G1/8"-G1/4"
3/2-5/2-5/3 spool valves with G1/8"-G1/4" threaded ports
- Installazione in qualsiasi posizione
Installation in any position
- Ampia gamma di azionamenti
Comprehensive range of actuations
- Valvole a leva e tiretto: filetto per montaggio a pannello M18x1.5
Push/pull and lever valves: thread for panel mounting M18x1.5
- Versione per attuatore da pannello (foro ø22)
Version for actuator for panel mounting (with ø22 hole)
- Esecuzioni speciali a richiesta
Special versions on request

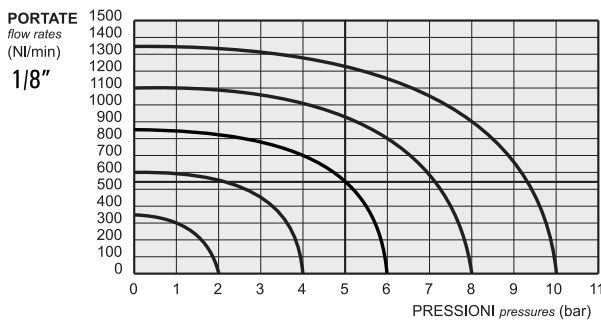

Materiali

Corpo: alluminio 11S

Comando e fondello: tecnopolimero (*)

Molle: INOX

Guarnizioni: NBR

Spola: alluminio nichelato

Parti interne: ottone OT58

Materials

Body: aluminium 11S

End caps: technopolymer (*)

Springs: stainless steel

Seals: NBR

Spool: nickel plated aluminium

Internal parts: brass OT58

(*) Su richiesta e dietro supplemento di prezzo, le valvole sono fornibili con corpo, comando e fondello interamente in alluminio. Alcune valvole, come di seguito specificato, sono disponibili solo nella versione in alluminio. Le valvole ATEX sono solo in alluminio.

Le parti in tecnopolimero recano impresso il logo

(*) On request and upon extra charge, the valves are available also with body and end caps entirely in aluminium. Some valves, as specified in the next pages, are available only in the aluminium version. ATEX valves are only in aluminium.

The parts in technopolymer are marked with the logo

Diametro nominale <i>Nominal orifice</i>		1/8": 5 mm 1/4": 7.5 mm			
Temperatura di esercizio <i>Temperature range</i>		max +60°C			
Pressione di esercizio <i>Working pressure</i>		azionam. diretto -0.9 ... 10 bar <i>direct actuation</i> -0.09 ... 1 MPa		az. servopilotato 2.5 ... 10 bar <i>servo-piloted actuation</i> 0.25 ... 1 MPa	
Forza di azionamento <i>Actuating force</i>	1/8" monost. [1/8" monost.]	1/4" monost. [1/4" monost.]	1/8" bistabile [1/8" bi-stable]	1/4" bistabile [1/4" bi-stable]	
	15 N		20 N		10 N
Fluido <i>Fluid</i>		Aria filtrata 50µ con o senza lubrificazione 50µ filtered, lubricated or non lubricated air			

valvole ad azionamento manuale

manually actuated valves



5213C ML90 centri chiusi
closed centres

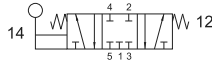

5213A ML90 centri aperti
open centres

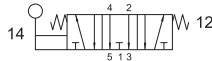

5213P ML90 centri in pressione
pressurized centres

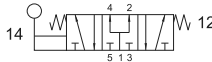

5/3 1/8" leva 90° - ritorno al centro

5/3 1/8" 90° lever - spring return to centre

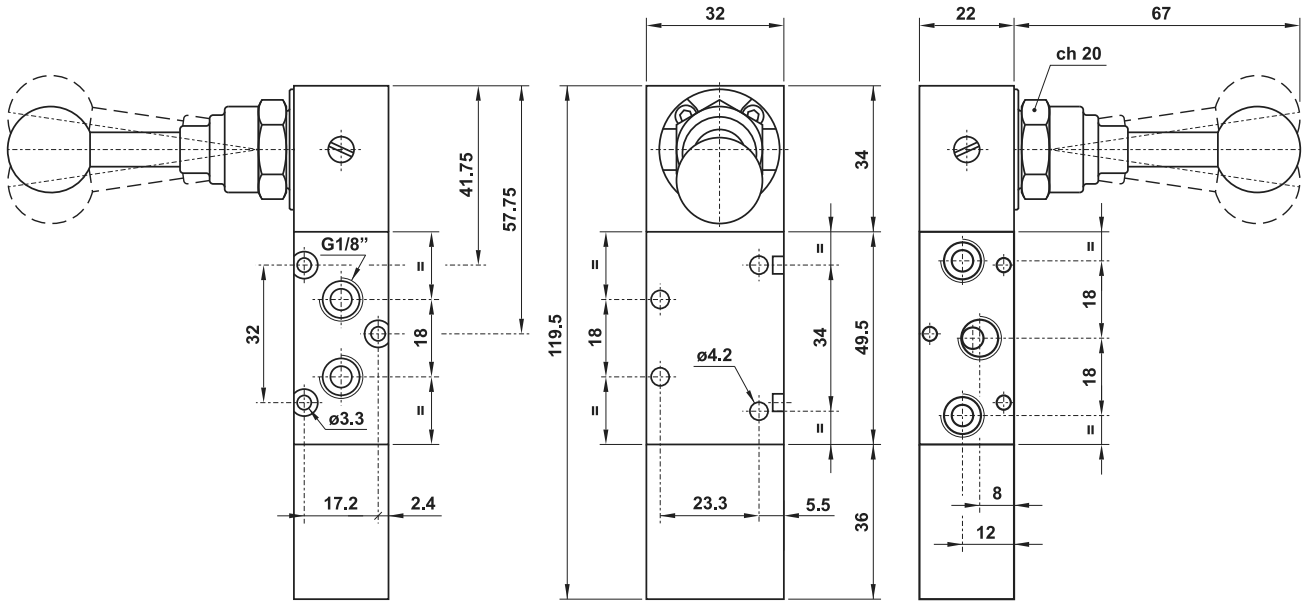
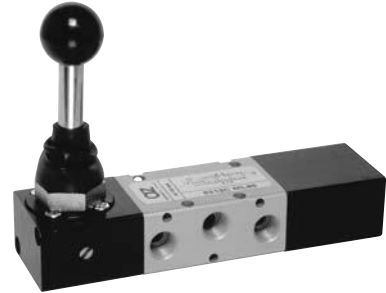

5213C LL90 centri chiusi
closed centres

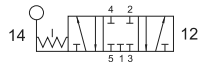

5213A LL90 centri aperti
open centres



5213P LL90 centri in pressione
pressurized centres



5/3 1/8" leva 90° - tre posizioni stabili

5/3 1/8" 90° lever - three detented positions

