

microvalvole

microvalves



- Microvalvole a otturatore NC e NA
NC and NO poppet microvalves
- Installazione in qualsiasi posizione
Installation in any position
- Attacchi filettati M5 o raccordi automatici per tubo $\varnothing 4$
M5 threaded ports or push-in fittings for $\varnothing 4$ tube
- Bassa forza di azionamento
Low actuating force
- Versione con adattatore (foro $\varnothing 22$) per montaggio a pannello
Version with adaptor for panel mounting (with $\varnothing 22$ hole)
- Esecuzioni speciali a richiesta
Special versions on request



Materiali

Corpo: alluminio 11S

Molla: INOX

Guarnizioni: NBR

Parti interne: ottone OT58

Materials

Body: aluminium 11S

Spring: stainless steel

Seals: NBR

Internal parts: brass OT58

Diametro nominale <i>Nominal orifice</i>	2.5 mm
Portata nominale a 6 bar <i>Nominal flow rate at 6 bar</i>	100 NI/min
Temperatura di esercizio <i>Temperature range</i>	max +60°C
Pressione di esercizio <i>Working pressure</i>	2 ... 10 bar 0.2 ... 1 MPa
Forza di azionamento <i>Actuating force</i>	6 N
Fluido <i>Fluid</i>	Aria filtrata 50 μ con o senza lubrificazione <i>50μ filtered, lubricated or non lubricated air</i>



305 MV

3/2 NC attacchi filettati M5 (sotto),
pulsante passa parete

3/2 NC M5 threaded ports (on the bottom),
panel mount tappet

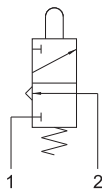

315 MV

3/2 NA attacchi filettati M5 (sotto),
pulsante passa parete

3/2 NO M5 threaded ports (on the bottom),
panel mount tappet

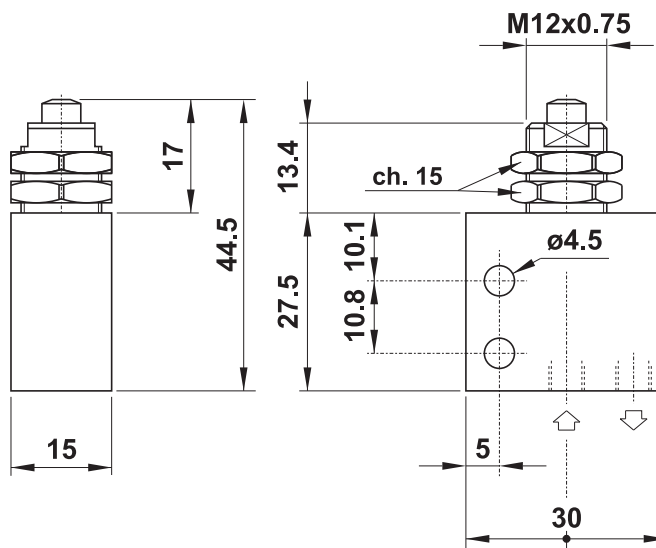
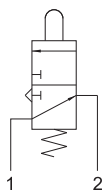

205 MV

2/2 NC attacchi filettati M5 (sotto),
pulsante passa parete

2/2 NC M5 threaded ports (on the bottom),
panel mount tappet

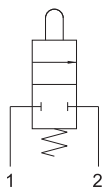

305 MA UL

3/2 NC attacchi filettati M5 (lateral),
pulsante

3/2 NC M5 threaded ports (on the side),
tappet

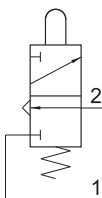

315 MA UL

3/2 NA attacchi filettati M5 (lateral),
pulsante

3/2 NO M5 threaded ports (on the side),
tappet

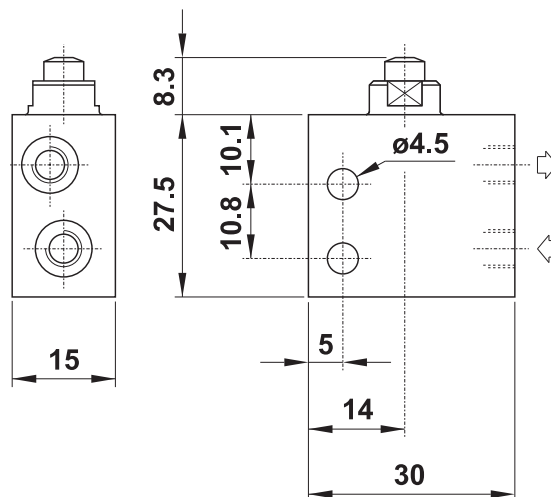
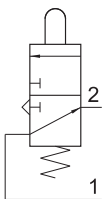

205 MA UL

2/2 NC attacchi filettati M5 (lateral),
pulsante

2/2 NC M5 threaded ports (on the side),
tappet

