

microvalvole

microvalves



- Microvalvole a otturatore NC e NA
NC and NO poppet microvalves
- Installazione in qualsiasi posizione
Installation in any position
- Attacchi filettati M5 o raccordi automatici per tubo $\varnothing 4$
M5 threaded ports or push-in fittings for $\varnothing 4$ tube
- Bassa forza di azionamento
Low actuating force
- Versione con adattatore (foro $\varnothing 22$) per montaggio a pannello
Version with adaptor for panel mounting (with $\varnothing 22$ hole)
- Esecuzioni speciali a richiesta
Special versions on request



Materiali

Corpo: alluminio 11S

Molla: INOX

Guarnizioni: NBR

Parti interne: ottone OT58

Materials

Body: aluminium 11S

Spring: stainless steel

Seals: NBR

Internal parts: brass OT58

Diametro nominale <i>Nominal orifice</i>	2.5 mm
Portata nominale a 6 bar <i>Nominal flow rate at 6 bar</i>	100 NI/min
Temperatura di esercizio <i>Temperature range</i>	max +60°C
Pressione di esercizio <i>Working pressure</i>	2 ... 10 bar 0.2 ... 1 MPa
Forza di azionamento <i>Actuating force</i>	6 N
Fluido <i>Fluid</i>	Aria filtrata 50 μ con o senza lubrificazione <i>50μ filtered, lubricated or non lubricated air</i>

microvalvole

microvalves



305 MGx

3/2 NC attacchi filettati M5 (sotto),
tasto (4 colori - vedi schema)

3/2 NC M5 threaded ports (on the bottom),
push button (4 colours - see explanation)

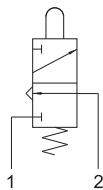

Nella sigla del prodotto sostituire la lettera "x" con l'indicazione del colore del tasto.
In the part number replace the letter "x" with the colour reference of the push button.

ROSSO - red	R
GIALLO - yellow	G
VERDE - green	V
NERO - black	N



315 MGx

3/2 NA attacchi filettati M5 (sotto),
tasto (4 colori - vedi schema)

3/2 NO M5 threaded ports (on the bottom),
push button (4 colours - see explanation)

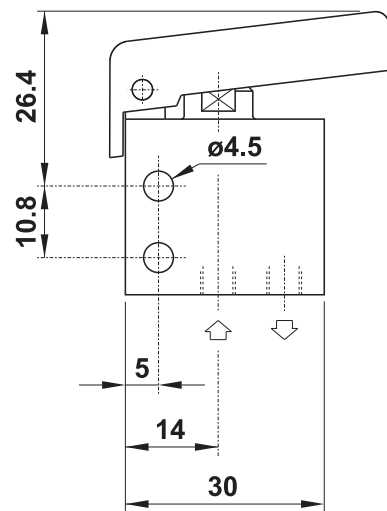
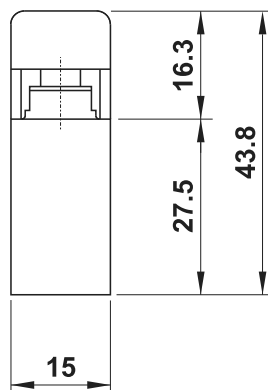
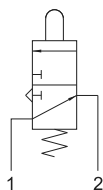

205 MGx

2/2 NC attacchi filettati M5 (sotto),
tasto (4 colori - vedi schema)

2/2 NC M5 threaded ports (on the bottom),
push button (4 colours - see explanation)

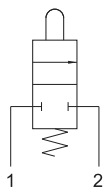

305 MGx UL

3/2 NC attacchi filettati M5 (lateral),
tasto (4 colori - vedi schema)

3/2 NC M5 threaded ports (on the side),
push button (4 colours - see explanation)

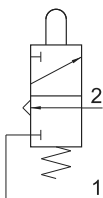

Nella sigla del prodotto sostituire la lettera "x" con l'indicazione del colore del tasto.
In the part number replace the letter "x" with the colour reference of the push button.

ROSSO - red	R
GIALLO - yellow	G
VERDE - green	V
NERO - black	N



315 MGx UL

3/2 NA attacchi filettati M5 (lateral),
tasto (4 colori - vedi schema)

3/2 NO M5 threaded ports (on the side),
push button (4 colours - see explanation)

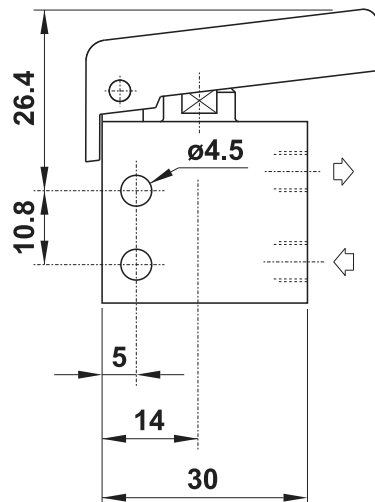
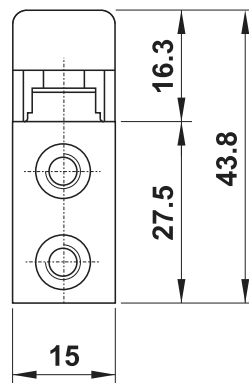
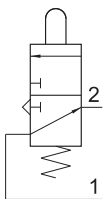

205 MGx UL

2/2 NC attacchi filettati M5 (lateral),
tasto (4 colori - vedi schema)

2/2 NC M5 threaded ports (on the side),
push button (4 colours - see explanation)

